



# User Manual

NA2-IO-DPRO  
for Mic, Line, AES I/O  
to DANTE™ Interface



**NEUTRIK®**

## Imprint

Subject to change due to advances in technology! This user manual corresponds to the level of technology at the time the product was delivered and not the current stage of development at Neutrik.

If any pages or sections of this user manual are missing, please contact the manufacturer at the address listed below.

### Copyright

This user manual is protected by copyright. The user manual must not be duplicated, reproduced, microfilmed or translated, nor must it be converted to be saved and processed in IT systems, neither in the form of excerpts nor in full, without the express written authorization of Neutrik.

Copyright by: © Neutrik® AG

### Document Identification

Document No: BDA 573

Version: V1 2019/08

Language: English

Original language: English

Each user manual in a different language is a translation of the operating manual in English.

### Manufacturer

Neutrik® AG

Im alten Riet 143

9494 Schaan

Liechtenstein

Phone: +423 2372424

Fax: +423 2325393

E: [neutrik@neutrik.com](mailto:neutrik@neutrik.com)

[www.neutrik.com](http://www.neutrik.com)



# Table of Contents

<b>1 About this Document</b> .....	<b>4</b>	5.5.9 Network Settings.....	32
1.1 Significance of the user manual.....	4	5.5.10 Firmware Upgrade.....	33
1.2 Designations.....	4	<b>5.6 Accessories assembly instructions</b> .....	<b>34</b>
1.3 Explanation of symbols.....	5	5.6.1 Mounting brackets.....	34
1.3.1 Symbols in illustrations.....	5	5.6.2 Rack panel.....	35
1.4 Target group.....	5	<b>6 After Operation</b> .....	<b>36</b>
<b>2 Safety</b> .....	<b>6</b>	6.1 Dismounting devices.....	36
2.1 Warning information and signal words.....	6	6.2 Transporting.....	36
2.2 Warning symbols.....	6	6.3 Storage.....	36
2.3 Important regulatory notes.....	6	6.4 Cleaning and care.....	36
2.3.1 Declaration of conformity.....	7	6.5 Maintenance and repair.....	36
2.4 Important safety instructions.....	7	6.6 Disposal.....	37
2.5 Intended use.....	7	<b>7 Appendix</b> .....	<b>38</b>
2.6 Foreseeable improper use.....	7	7.1 Technical specifications.....	38
<b>3 Components and Accessories</b> .....	<b>8</b>	7.2 PoE (Power over Ethernet).....	40
<b>4 Description of the Product</b> .....	<b>9</b>	7.2.1 Definitions.....	40
4.1 What is the DPRO Adapter?.....	9	7.2.2 PoE Standards.....	40
4.2 Device.....	9	7.2.3 Classes and discovery process.....	40
4.3 Connections and displays.....	9		
4.3.1 Overview front.....	9		
4.3.2 Overview rear.....	10		
4.3.3 Modes and switching logic of the DPRO Adapter.....	11		
4.4 DPRO Controller.....	11		
4.4.1 General overview.....	11		
4.4.2 Create Preset page.....	15		
4.4.3 Load Preset page.....	16		
4.4.4 Load Preset mismatch page.....	17		
4.4.5 Reset Devices window.....	18		
4.4.6 About Device (Device Settings) window.....	18		
4.4.7 Network Settings window.....	19		
4.4.8 Firmware Upgrade window.....	19		
4.4.9 About Software window.....	20		
<b>5 Operation</b> .....	<b>21</b>		
5.1 Preparations.....	21		
5.2 Connecting devices with the DPRO Adapter.....	21		
5.2.1 Power setup using a switch with PoE support.....	22		
5.2.2 Power setup using a switch without PoE sup- port.....	22		
5.3 Applications.....	23		
5.3.1 Redundant Mode.....	23		
5.3.2 Switched Mode (Daisy-chained).....	23		
5.4 Linking devices with the Dante™ controller.....	24		
5.4.1 Enabling a Dante™ link.....	24		
5.5 DPRO Controller App.....	24		
5.5.1 Downloading and installing DPRO Controller App.....	24		
5.5.2 Connecting devices with the app.....	25		
5.5.3 Selecting the device to edit.....	25		
5.5.4 Setting input parameters.....	25		
5.5.5 Setting output parameters.....	26		
5.5.6 Presets.....	27		
5.5.7 Identify device.....	30		
5.5.8 Reset device.....	31		



# 1 About this Document

This user manual provides an overview of the necessary operation steps and settings on the product.

## 1.1 Significance of the user manual

**i** This user manual is an integral component of the product and part of the product's safety concept.

- ▶ Make sure that all persons who work with the product have fully read and also understood this user manual.
- ▶ Observe all instructions exactly, especially the safety instructions.

**i** This user manual contains important information on safely and properly operating the product.

- ▶ Keep this user manual in the immediate vicinity of the product so personnel have access to it at all times.

- ▶ Pass this user manual on to every user, e.g., by lending it, or to the future owner of the product.
- ▶ If this user manual is lost or damaged, a copy of it can be downloaded from the Neutrik's website ([www.neutrik.com](http://www.neutrik.com)).

## 1.2 Designations

Designation	Explanation
DPRO Adapter	DPRO Adapter NA2-IO-DPRO; to ensure the text is easy-to-read, the device is hereinafter referred to as DPRO Adapter.
Dante™ audio networking	Dante™ audio networking (hereinafter referred to as Dante™) Dante™ stands for <b>D</b> igital <b>A</b> udio <b>N</b> etwork <b>T</b> hrough <b>E</b> thernet and is an audio network protocol developed by the Australian company Audinate. Dante™ delivers uncompressed, multi-channel, low-latency digital audio over a standard Ethernet network using Layer 3 IP packets.
PoE	Power over Ethernet; the device is supplied with power via the network connection.
Peripheral devices	Any device that can be connected to the DPRO Adapter: audio sources (transmitters) and audio sinks (receivers)
Audio source	Any device that emit an audio signal
Audio sink	Any device that receives audio signals, such as loudspeakers, audio systems (amplifiers, mixing consoles, etc.)

## 1.3 Explanation of symbols

Uniform safety instructions, symbols, terms and abbreviations were used to make this user manual easier to understand. The following symbols designate instructions that are not relevant to safety, but make the operating manual easier to understand.

- ✔ The preconditions for an action are depicted with this symbol. Complete the items as listed before carrying out the action steps that follow.
- ▶ Action steps are designated by this symbol. Carry out the action steps in the order they are presented.
- ✔ The result of the action or the reaction of the product to the action are depicted with this symbol.
  - Lists without a mandatory sequence are presented as a list with this bullet.
  - 1. Numbered listings are displayed in this manner.
  - (1) Refers to a position in an illustration.



Wherever you see this symbol, you will find useful information for safe, trouble-free operation of the product.

### 1.3.1 Symbols in illustrations

Symbol	Explanation
	Image position
	Action steps numbered in an illustration. Carry out the action steps in the order they are presented.
	Only carry out these tasks when using OS X.
	Only carry out these tasks when using Windows.

## 1.4 Target group

This user manual is intended for sound engineers and professional personnel who have detailed experience in sound and event technology.

## 2 Safety

### 2.1 Warning information and signal words

Special warning information regarding potential dangers inherent in a particular action are presented before instructions for an action. The warnings are ranked as follows:

**⚠ CAUTION**

**Potential risk of danger!**

This type of warning points out a situation that could result in minor or moderate injuries.

- ▶ Minor injuries may result if this warning is ignored.

**⚠ NOTE**

**Potential risk of property damage!**

This type of warning points out a situation that could result in damage to the device and its components.

- ▶ Property damage may result if the warning is ignored.

### 2.2 Warning symbols

Symbol	Warning
	General warning
	Warning of hearing impairment

### 2.3 Important regulatory notes

This equipment has been tested and found to comply with the limits for a Class B digital device, pursuant to Part 15 of the FCC Rules. These limits are designed to provide reasonable protection against harmful interference in a residential installation. This equipment generates, uses and may radiate radio frequency energy and, if not installed and used in accordance with the instructions, may cause harmful interference to radio communications. However, there is no guarantee that interference will not occur in a particular installation. If this equipment does cause harmful interference to radio or television reception, which can be determined by turning the equipment off and on, the user is encouraged to try to correct the interference by attempting one or more of the following measures:

- Reposition or relocate the receiving antenna.
- Increase the distance between the equipment and receiver.
- Connect the equipment to an outlet on a circuit different from to the one that the receiver is connected to.
- Consult the dealer or an experienced radio/TV technician for help.

**⚠ NOTE**

Changes or modifications made to this equipment not expressly approved by Neutrik may void the FCC authorization to operate this equipment.

### 2.3.1 Declaration of conformity

The device meets all the relevant EU directives and therefore has the CE and EAC marking. The Declaration of Conformity may be viewed at [www.neutrik.com/en/approvals-and-certificates](http://www.neutrik.com/en/approvals-and-certificates).

## 2.4 Important safety instructions

Avoid property damage to the DPRO Adapter due to unsuitable operating and environmental conditions:

- Never immerse in water.
- Protect from strong sunlight.
- Never install the device near heat sources such as radiators, heating units, ovens or stoves.
- To avoid overheating, never cover the device.
- Protect the device from impact and above all, from falling from poles, stages, tables or furniture.

### Repair

#### NOTE

##### **Property damage due to improper repair!**

The DPRO Adapter does not contain any parts that you can repair yourself. Opening or repairing the devices on your own may result in severe damage to the device.

- ▶ Do not open the housing of the DPRO Adapter under any circumstances.
- ▶ Do not change any parts yourself.
- ▶ Only have the DPRO Adapter repaired by a authorized specialist dealer.

### Information for operation

- ▶ Ensure that the ambient conditions specified for the DPRO Adapter are observed during operation.
- ▶ Do not use the DPRO Adapter if it is not functioning properly, has fallen or been damaged, has become wet or if parts of it have been immersed in water.
- ▶ If disruptions occur during operation:  
Immediately disconnect the DPRO Adapter from audio sources and/or audio sinks.
- ▶ Do not operate the DPRO Adapter in environments where flammable or explosive materials, gases or vapors are present or might occur.

## 2.5 Intended use

The DPRO Adapter is designed for converting the signal of an analog LINE/MIC or digital AES/EBU audio signal into a Dante™ signal. Dante™ signals can also be converted into analog LINE signals.

## 2.6 Foreseeable improper use

The DPRO Adapter is not suitable for use outdoors and in potentially explosive atmospheres.

### 3 Components and Accessories

The device and the accessories can be ordered separately.



Pos.	Description	Item no.
1	DPRO Adapter (device)	NA2-IO-DPRO
2	Mounting brackets (Kit includes 2 brackets, 2 fixing screws, 2 torx screws and 2 spacers)	NA-MB-KIT
3	Rack panel	NRP1RU-2A
4	Removable rubber protection	NA-RC



## 4 Description of the Product

### 4.1 What is the DPRO Adapter?

The DPRO Adapter is a 2IN, 2OUT breakout box designed to connect legacy audio equipment to the Dante network. It features high-quality microphone preamps and 2 Dante ports for either redundant setup or daisy chaining. Audio parameters are adjusted by the DPRO Controller app.

All the connectors are lockable and, together with the removable rubber protector, offer a reliable solution for tough stage conditions. With optional mounting brackets or a rack panel, the box can be mounted below tables, in floor boxes, racks or on the truss.

### 4.2 Device



Pos.	Description
1	Sheet metal housing
2	Rubber protection (removable)

### 4.3 Connections and displays

#### 4.3.1 Overview front

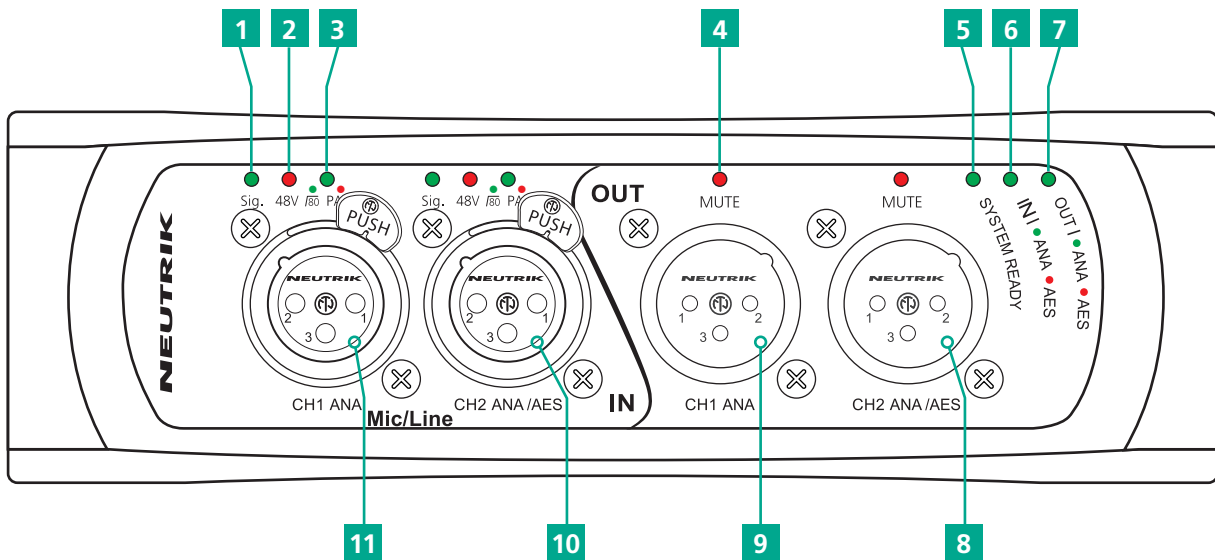



Pos.	Description
1	<b>Signal Present LED</b> Indicates the signal status. <ul style="list-style-type: none"> <li>• LED lights up green/yellow/red: signal available, color indicates the signal level, see section "Meter bar" on page 15.</li> <li>• LED off: no signal.</li> </ul>
2	<b>Phantom power 48V LED</b> Indicates, if Phantom power is active. <ul style="list-style-type: none"> <li>• LED lights up red: Phantom power active.</li> <li>• LED off: Phantom power not active.</li> </ul>
3	<b>HPF/Pad LED</b> Indicates, if HPF or Pad is active. <ul style="list-style-type: none"> <li>• LED lights up red: Pad</li> <li>• LED lights up green: HPF</li> <li>• LED flashes green and red: Pad and HPF active.</li> </ul>
4	<b>Output MUTE LED</b> Indicates, if output is muted. <ul style="list-style-type: none"> <li>• LED lights up red: Mute active.</li> <li>• LED off: Mute not active.</li> </ul>

Pos.	Description
5	<b>System Ready LED</b> Indicates the device's system status. <ul style="list-style-type: none"> <li>• LED lights up red: system is starting.</li> <li>• LED lights up green: system is ready.</li> </ul>
6	<b>Input type LED</b> Indicates the device input status. <ul style="list-style-type: none"> <li>• LED lights up green: Analog mode.</li> <li>• LED lights up red: Digital mode.</li> </ul>
7	<b>Output type LED</b> Indicates the device output status <ul style="list-style-type: none"> <li>• LED lights up green: Analog mode.</li> <li>• LED lights up red: Digital mode.</li> </ul>
8	<b>Balanced XLR output 2</b> <ul style="list-style-type: none"> <li>• Output for analog/digital line signals.</li> </ul>
9	<b>Balanced XLR output 1</b> <ul style="list-style-type: none"> <li>• Output for analog line signal only.</li> </ul>
10	<b>Balanced XLR input 2</b> <ul style="list-style-type: none"> <li>• Input for analog/digital line signals.</li> </ul>
11	<b>Balanced XLR input 1</b> <ul style="list-style-type: none"> <li>• Input for analog line signal only.</li> </ul>

### 4.3.2 Overview rear

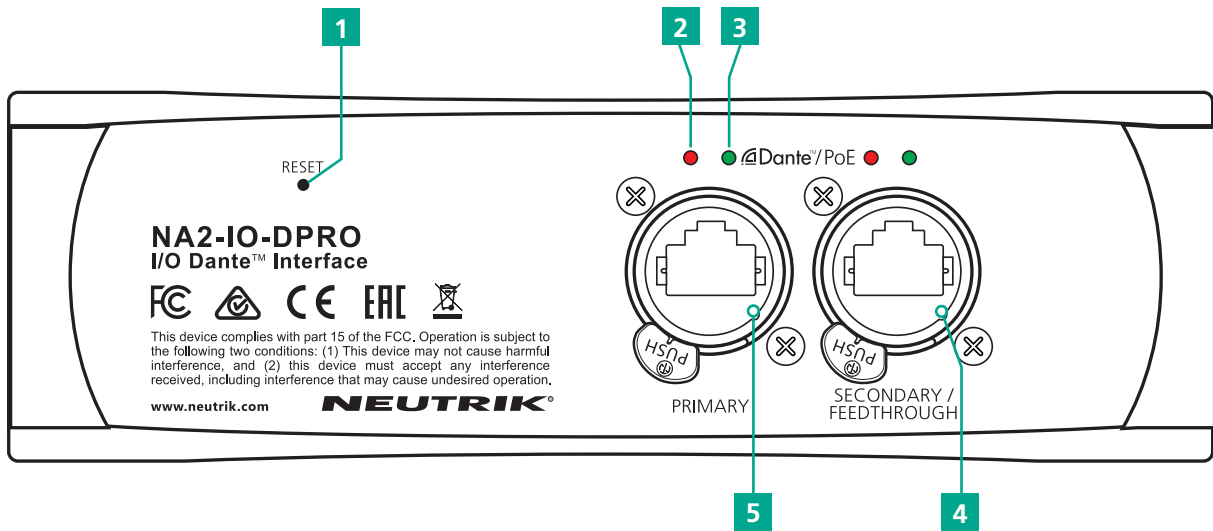

Pos.	Description
1	<b>Reset Button</b> <ul style="list-style-type: none"> <li>• Press to delete all set parameters. A detailed description see in section "5.5.8 Reset device" on page 32.</li> </ul>
2	<b>Link LED</b> Indicates the Ethernet connection status. <ul style="list-style-type: none"> <li>• LED is red: Ethernet connection is established.</li> <li>• LED off: no Ethernet connection.</li> </ul>

Pos.	Description
3	<b>Active LED</b> Indicates the data transmission status. <ul style="list-style-type: none"> <li>• LED flashes green: data transmission established.</li> <li>• LED off: no data transmission.</li> </ul>
4	<b>Secondary Network connection (RJ45)</b> Secondary Dante® Interface/Feedthrough/PoE input (Redundant mode for standalone redundant purpose, Switched mode for daisy-chaining)
5	<b>Primary Network connection (RJ45)</b> Primary Dante® Interface/PoE input

### 4.3.3 Modes and switching logic of the DPRO Adapter

Switchable contacts in the DPRO adapter work in 2 ways:

- If the signal is analog, connect channel 1 and channel 2 (valid for input and output).
- If the signal is AES, connect channel 2 only (valid for input and output).

**i** AES carries 2 separate signals over 1 physical cable. Therefore AES is occupying both channels and channel 1 becomes inactive. It's not possible to combine an analog signal on channel 1 and AES on channel 2, as this would mean 3 separate signals are present. In this case channel 1 will have a priority and only the analog signal will be present. This is valid for input and output.

#### **⚠ CAUTION**



#### **Danger of hearing damage!**

Signal peaks may occur as a consequence of incorrect connections.

- ▶ Do not connect AES/EBU signal to input 1.
- ▶ Do not connect amplifiers or other analog devices to output 2 (AES) if there is no connection on output 1 (ANA).

## 4.4 DPRO Controller

DPRO Controller allows to control audio parameters, monitor the status of the device, recall, save and load presets. The app is available for PC and Mac.

### 4.4.1 General overview

#### Analog inputs and outputs



Pos.	Description
1	Menu
2	Device status Shows the status of the selected device.
3	Output settings
4	Input settings
5	Link to Dante Controller
6	Connected devices The selected device is marked with a green line on the left side.

## Menu

Menu	Option	Shortcut	Description
File	Create Preset	Ctrl/Command + N	Opens a new Preset window.
	Load Preset	Ctrl/Command + L	Applies created preset to devices.
	Save As Preset	Ctrl/Command + S	Saves presets as .dap file on user's computer.
	Quit	Windows: Alt + F4, Ctrl + Q Mac: Command + Q	Quits the App.
Device	Identify Device	Ctrl/Command + I	Identifies the selected device. The LEDs on the front of the device flash red for 10 seconds.
	Reset Device		Deletes all set parameters on the selected device.
	About Device		Opens a window with general information of the selected device.
	Network Settings		Opens a window with network settings.
	Firmware Upgrade		Opens a window with firmware information of the selected device. <ul style="list-style-type: none"> <li>Shows the version of the installed firmware.</li> <li>Install firmware upgrade.</li> </ul>
Help	About Software		Opens a window with general information about the DPRO Controller app and credits.

## Further software functions/shortcuts

Option/Function	Shortcut	Description
Fader	Ctrl/Command + click on fader	Fader jumps to 0.

## Device Status

This overview indicates the device status. The description of the LEDs can be found in chapter "4.3.1 Overview front" on page 9.



Symbol	Description
	<b>Identify device button</b> Click on the button to identify the selected device. LEDs of XLR Inputs and XLR Outputs of the device flash up for 10 seconds.
	<b>Settings button</b> Click on the button to open the <a href="#">Settings</a> window.

## Input Channels



Analog Inputs

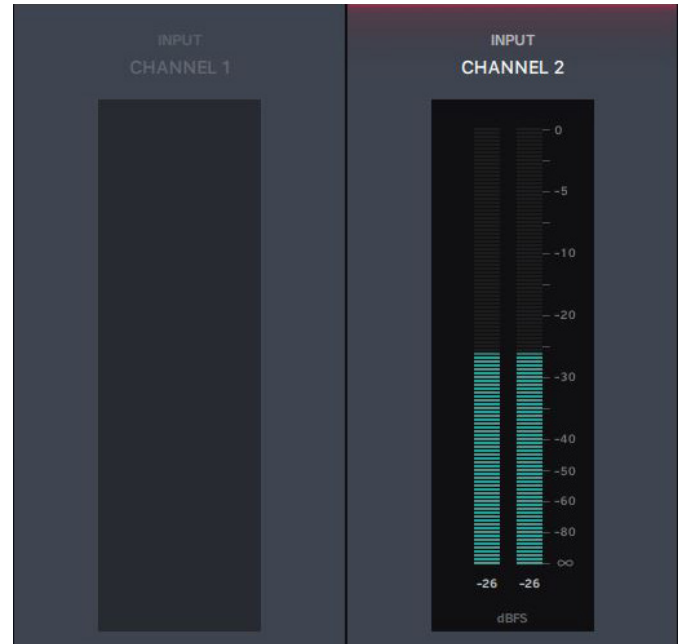

AES Inputs: Channel 1 becomes inactive

Symbol/button		Description
Normal	Active	
		<b>Microphone/Line Signal button</b> Indicates, if the signal has MIC or LINE input sensitivity. Click on the button to change the sensitivity. <b>Position MIC:</b> Microphone level <b>Position LINE:</b> Line level
		<b>Low-cut filter button</b> Activates the low-cut filter for the input signal.
		<b>Phantom power button</b> (only with MIC signal) Activate this function if the microphone requires phantom power.
		<b>PAD button</b> Activate this function to apply 16 dB attenuation.
		<b>Link/Unlink button</b> Click this button to link or unlink the input/output signals.
		<b>Gain</b> (only with MIC signal) Adjusts the input sensitivity.

## Output Channels



Analog Outputs



AES Outputs: Channel 1 becomes inactive

Symbol/button		Description
Normal	Active	
		Mute button Activate to mute the output signal.
		Link/Unlink button Click this button to link or unlink the input/output signals.

## Meter bar

The Meter bar allows the signal level to be monitored on both input and output.

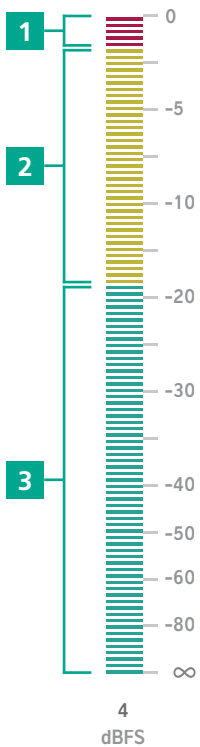

Pos.	Description
1	Red area: 0 dBFS to -3 dBFS
2	Yellow area: -3 dBFS to -18 dBFS
3	Green area: -18 dBFS to infinite

## 4.4.2 Create Preset page

With presets, settings of the devices can be stored for a later use. Presets can be also created and stored if no device is connected or online. After adjusting the parameters, the preset can be saved as .dap file locally on the computer.

- Menu: [File](#) > [Create Preset](#)
- Shortcut: Ctrl/Cmd + N

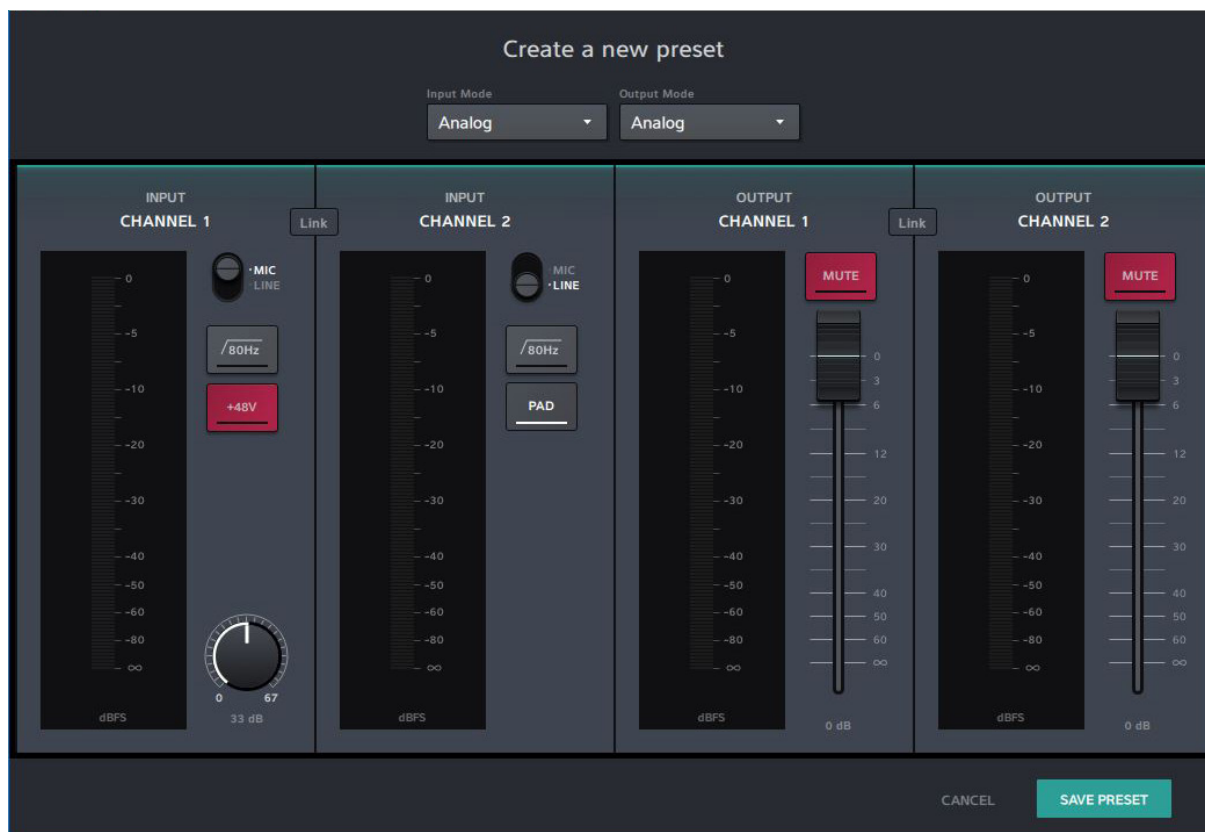

Button / Screen text	Description
<b>CANCEL</b>	Close the window without saving the preset.
<b>SAVE PRESET</b>	Save the preset as .dap file on the computer.



### 4.4.3 Load Preset page

Load a preset from a .dap file from the computer.

- Menu: [File](#) > [Load Preset](#)
- Shortcut: Ctrl/Cmd + L

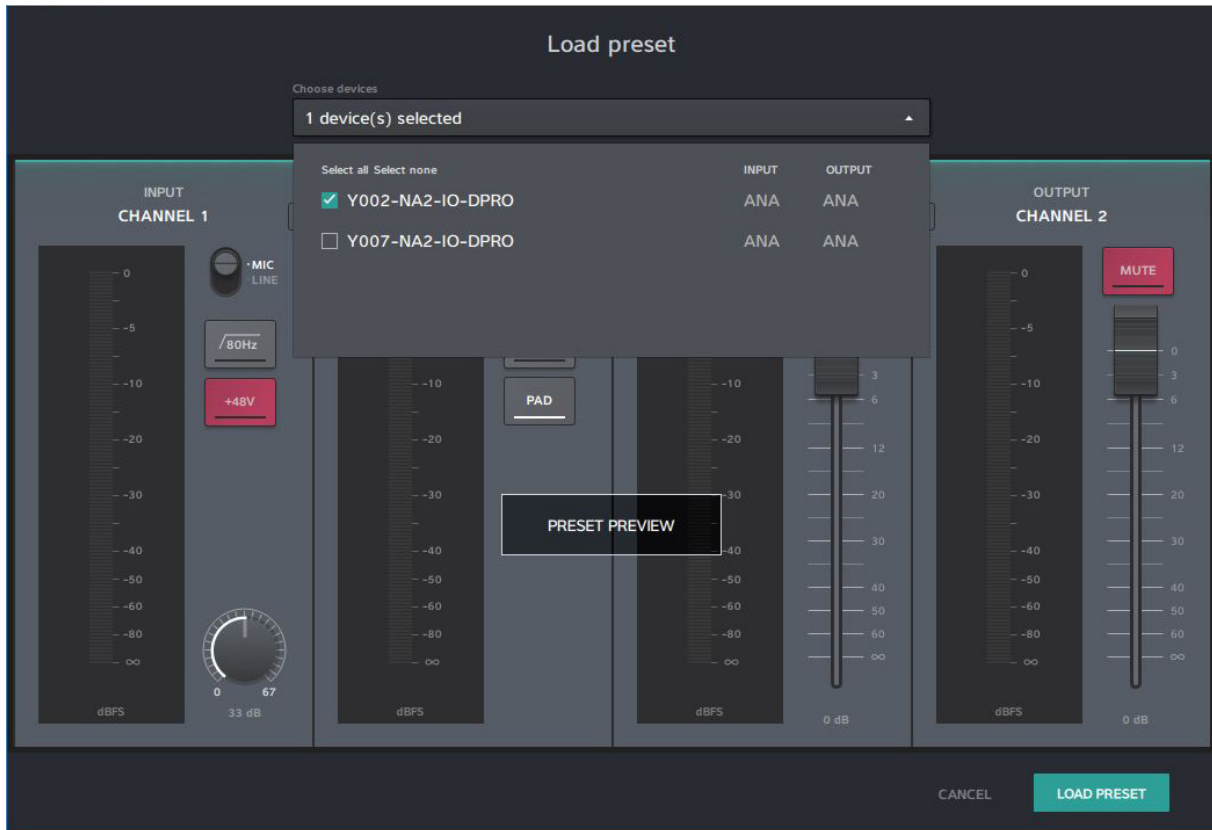

Button / Screen text	Description
<b>Choose devices</b>	Select the settings of one or more devices and load as preset. Select all: Select all devices in the list. Select none: Select no device in the list. <input type="checkbox"/> Checkbox: not selected <input checked="" type="checkbox"/> Checkbox: selected
<b>PRESET PREVIEW</b>	Preview window of the settings which will be loaded with the preset.
<b>CANCEL</b>	Close the window without loading the preset.
<b>LOAD PRESET</b>	Load preset with the selected device settings.

## Mismatch

Loading of the preset(s) was not successful. The mode of the preset do not match with device mode (e.g. Preset is saved with AES mode, device works in analog mode). More information about the modes and switching logic please find in section "4.3.3 Modes and switching logic of the DPRO Adapter" on page 11.

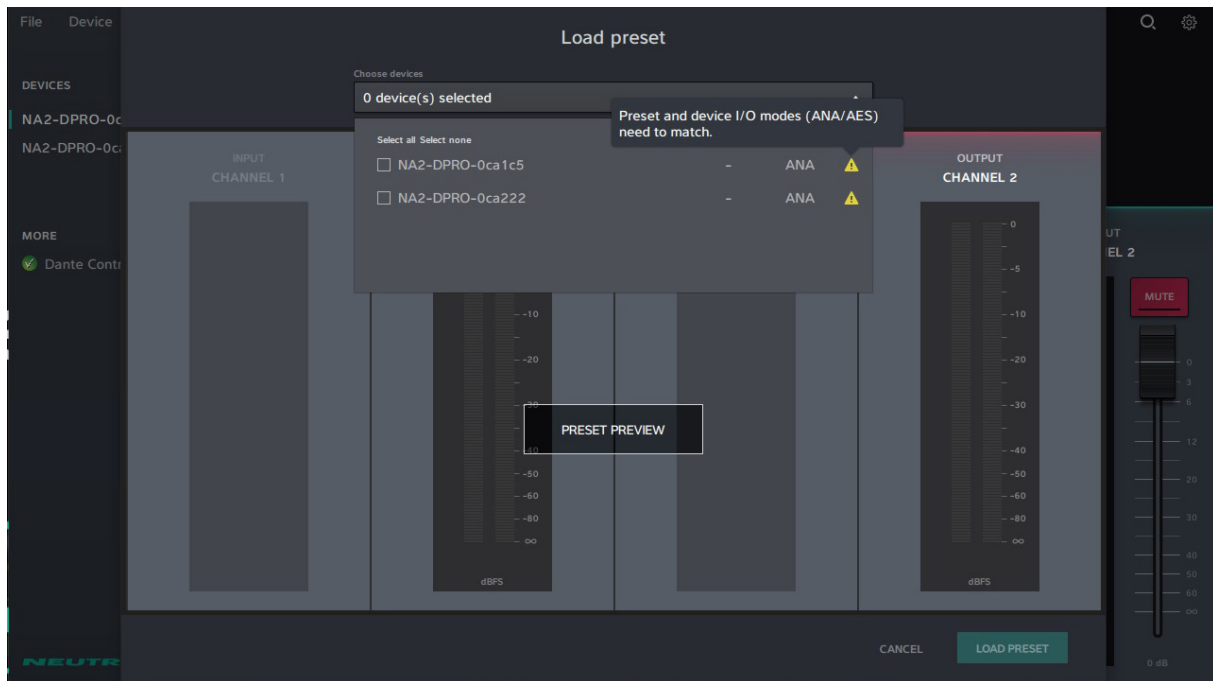

Icon	Description
	Warning Icon. Indicates a mismatch.

#### 4.4.4 Reset Devices window

This function resets the selected devices to factory settings. The reset function is described in section "5.5.8 Reset device" on page 32.

- Menu: [Device](#) > [Reset Device](#)

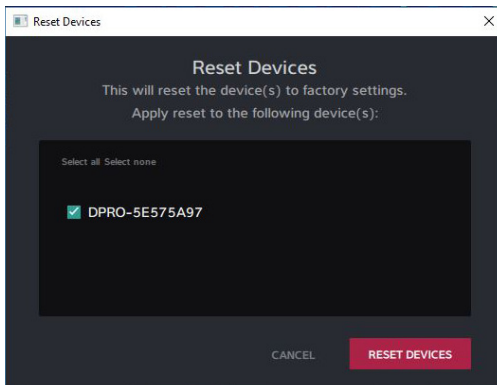

Button / Screen text	Description
<b>CANCEL</b>	Close the window without resetting devices.
<b>RESET DEVICES</b>	Reset selected devices to factory settings. <b>Select all:</b> Select all devices in the list. <b>Select none:</b> Select no device in the list. <input type="checkbox"/> not selected <input checked="" type="checkbox"/> selected

#### 4.4.5 About Device (Device Settings) window

This window shows general information about the selected device.

- Menu: [Device](#) > [About Device](#)

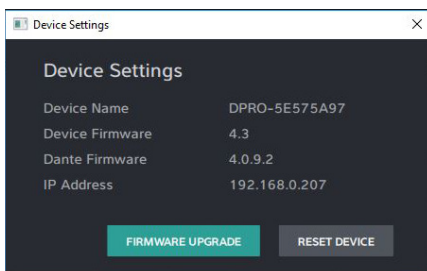

Button / Screen text	Description
<b>Device name</b>	Name of the selected device.
<b>Device Firmware</b>	Current Neutrik firmware version installed on the device.
<b>Dante Firmware</b>	Current Dante firmware version installed on the device.
<b>IP Address</b>	IP address of the device in the network.
<b>FIRMWARE UPGRADE</b>	Opens a window to upgrade the Neutrik's firmware on the device.
<b>RESET DEVICE</b>	Reset device to factory settings.

### 4.4.6 Network Settings window

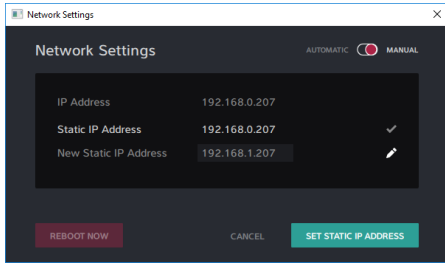

Button / Screen text	Description
<b>AUTOMATIC</b>	The device obtains the IP address from DHCP server or locally from the computer.
<b>MANUAL</b>	The device's IP address can be entered manually.
<b>IP Address</b>	IP address obtained from DHCP or local computer. Active, if <b>AUTOMATIC</b> is active.
<b>Static IP Address</b>	Entered IP address by user. Checked IP address is active.
<b>New Static IP Address</b>	Enter a new static IP address by clicking the  icon.
<b>REBOOT NOW</b>	Reboots the device.
<b>CANCEL</b>	Close the window without any change.
<b>SET STATIC IP ADDRESS</b>	Set the chosen static IP address.

### 4.4.7 Firmware Upgrade window

Upgrade the Neutrik firmware on the device.

- Menu: [Device](#) > [Firmware Upgrade](#)

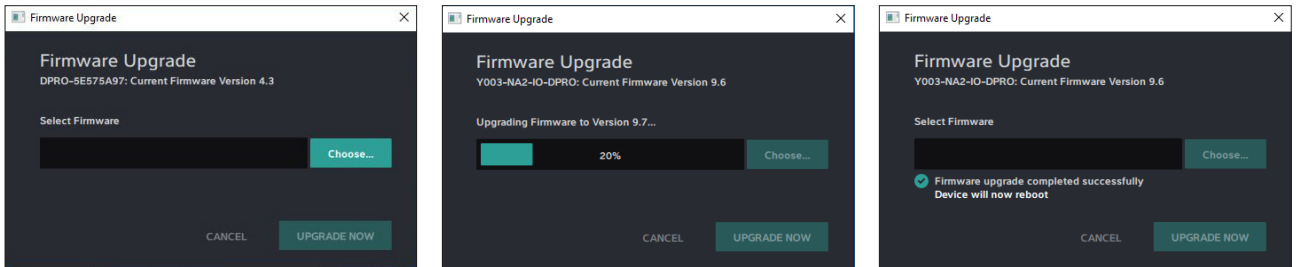

Button / Screen text	Description
<b>[Device Name]: Current Firmware Version X.X</b>	Information about the current device firmware.
<b>Select Firmware</b>	Select the downloaded upgrade file.
<b>CANCEL</b>	Close the window without upgrading firmware.
<b>UPGRADE NOW</b>	Install firmware from the selected upgrade file.
<b>Upgrading Firmware to Version X.X</b>	Progress bar informs about the firmware upgrade progress.
<b>Firmware upgrade completed successfully</b>	Information that firmware upgrade is complete. Device will reboot after successful upgrade.

## 4.4.8 About Software window

General information about the app.

- Menu: [Help](#) > [About Software](#)

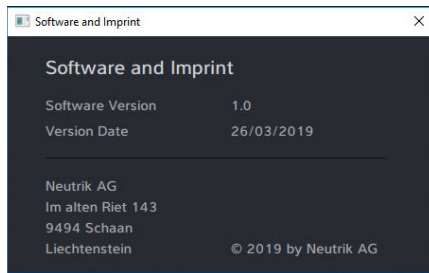

Button / Screen text	Description
<b>Software Version</b>	Version of the DPRO Controller app.
<b>Version Date</b>	Release date of the app version.

## 5 Operation

### 5.1 Preparations

- ▶ Unpacking the DPRO Adapter.
- ▶ Save packaging for later transport and storage.
- ▶ Check the packaging and DPRO Adapter for visible damage.
- ▶ When visible damage to the packaging and/or delivered parts is detected: Contact the salesperson or Neutrik sales partner.
- ▶ Do not use damaged devices under any circumstances.

### 5.2 Connecting devices with the DPRO Adapter

The DPRO Adapter can be connected to a Dante™ network via a standard 1 Gbit/s twisted-pair Ethernet cable (CAT5e). This connection is responsible for the data transfer as well as for the power supply. Depending on the cable length and shield, we do not recommend installing cables parallel to power supply lines.

**i** The DPRO Adapter **requires a switch that supports PoE (48 V). If a switch without PoE support is available, a PoE injector (compatible with 802.3af or 802.3at) must be connected in series.**

**⚠ CAUTION**

**⚠ Danger of hearing damage!**  
Signal peaks may occur when an audio source or sink is connected.  
▶ Before making connections, mute the signal path of the peripheral devices.

**⚠ CAUTION**

**⚠ Danger of hearing damage!**  
Signal peaks may occur as a consequence of incorrect connections.  
▶ Do not connect AES/EBU signal to input 1.  
▶ Do not connect amplifiers or other analog devices to output 2 (AES) if there is no connection on output 1 (ANA).

Front

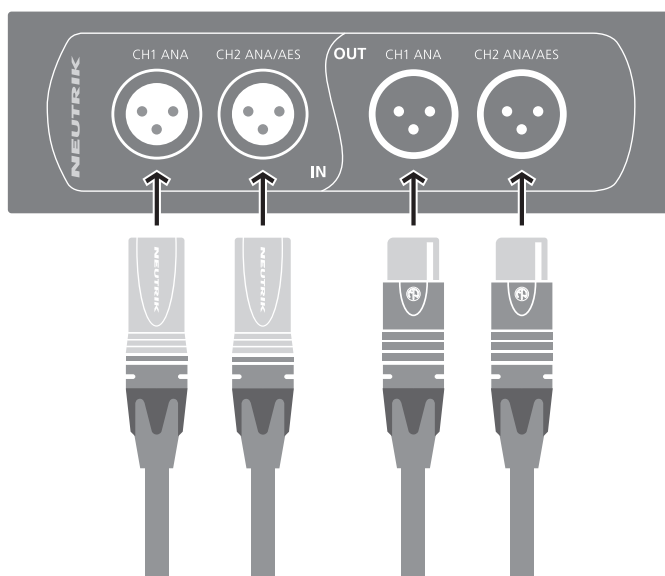

Rear

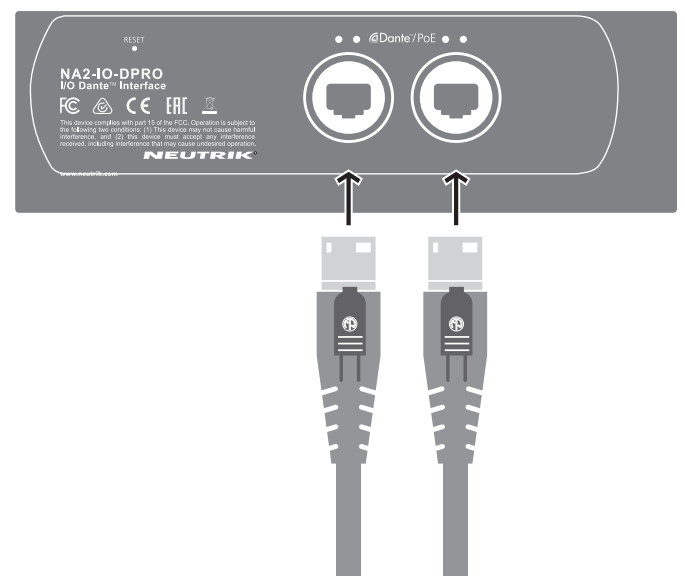

- ▶ Connect the device depending on the desired application:  
 Analog signal: Use channel 1 and Channel 2.  
 AES signal: Use channel 2.
- ▶ Connect the DPRO Adapter to the PoE switch using a network cable.
- ▶ If the switch does not support PoE:  
 Use a PoE injector.
- ✓ LEDs light up once the DPRO Adapter is supplied with power via the switch or the PoE injector.
- ✓ The DPRO Adapter is ready for operation.
- ✓ Set up the desired audio connection with the "Dante™ controller" software.

### 5.2.1 Power setup using a switch with PoE support

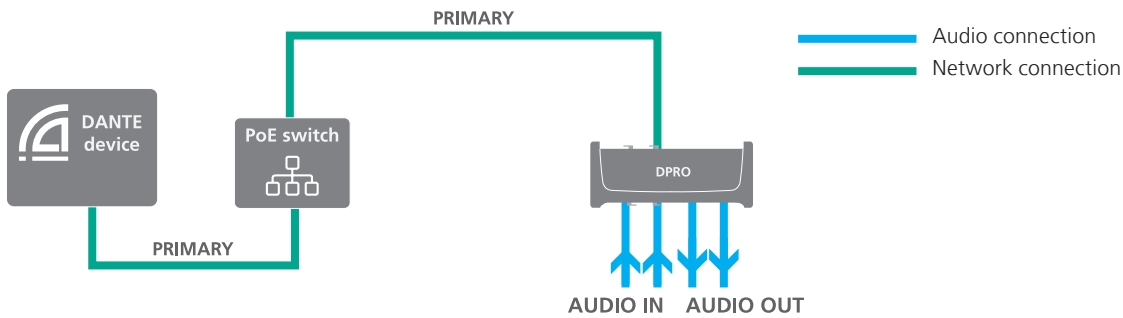

**i** The DPRO Adapter forwards information to the PoE switch indicating that it is a "Class 2" device to ensure the correct power supply.

### 5.2.2 Power setup using a switch without PoE support

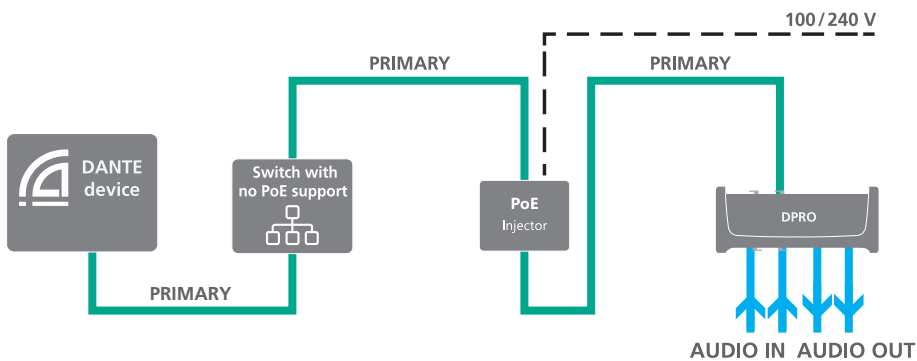

For power and data redundancy, use 2x passive PoE injectors. Because they do not use the discovery process, switching between primary and secondary will not result in a short loss of audio. More information about PoE please find in section "7.2 PoE (Power over Ethernet)" on page 41.

**i** Do not use two different passive PoE injectors (such as from different manufacturers), because this might cause a short circuit and make the device inoperable.

## 5.3 Applications

### 5.3.1 Redundant Mode

In Redundant mode, two copies of all the Dante™ information (audio, clock etc.) are sent across in two separate networks to ensure uninterrupted signal flow in case one network goes down.

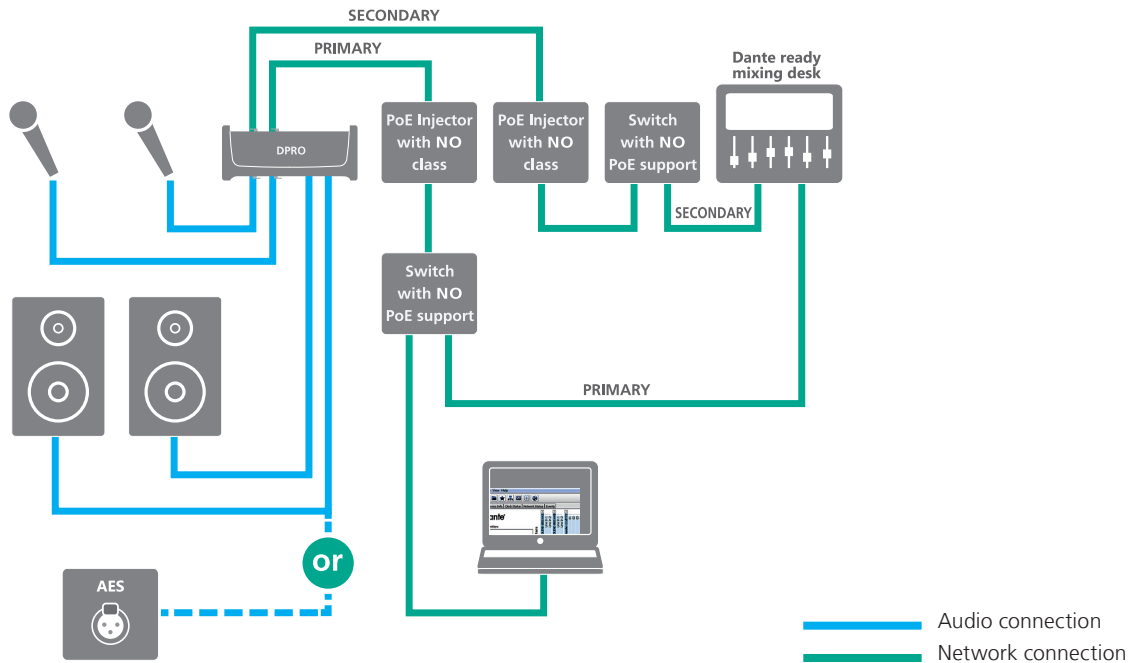

### 5.3.2 Switched Mode (Daisy-chained)

In the Switched mode, you can daisy-chain several devices to increase channel count. Only passive injectors are able to deliver steady power to all the daisy-chained units.

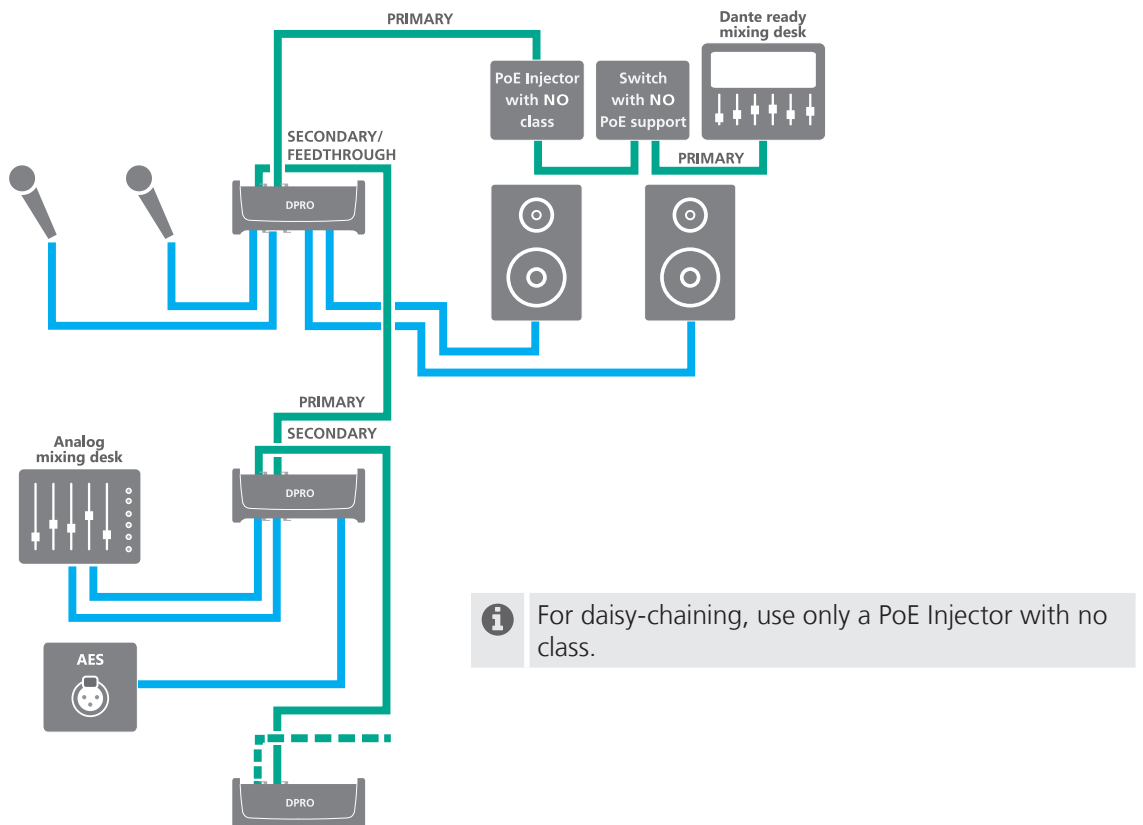

**i** For daisy-chaining, use only a PoE Injector with no class.



## 5.4 Linking devices with the Dante™ controller

The Dante™ controller is a free software application that enables routing of audio signals and configuring devices in a Dante™ network. Setting up a Dante™ network is very easy. The Dante™ controller offers automatic device detection, one-click signal routing and user-editable device and channel labeling.

The software together with tutorials and guides are available on the Audinate website ([www.audinate.com](http://www.audinate.com)).

### 5.4.1 Enabling a Dante™ link

- ▶ Download and install the "Dante™ Controller" software. ([www.audinate.com](http://www.audinate.com)).
- ▶ Connect the computer to the switch using a standard network cable.
- ▶ Run the "Dante™ Controller" software.
- ▶ In the routing menu, click the + symbols of the devices.
- ▶ Establish the desired link.

 The DPRO Adapter is displayed in the "Dante™ Controller" as a NA2DPRO by default, followed by a suffix with the last 6 digits of the MAC address. This name can be customized for each device in the Dante™ controller.

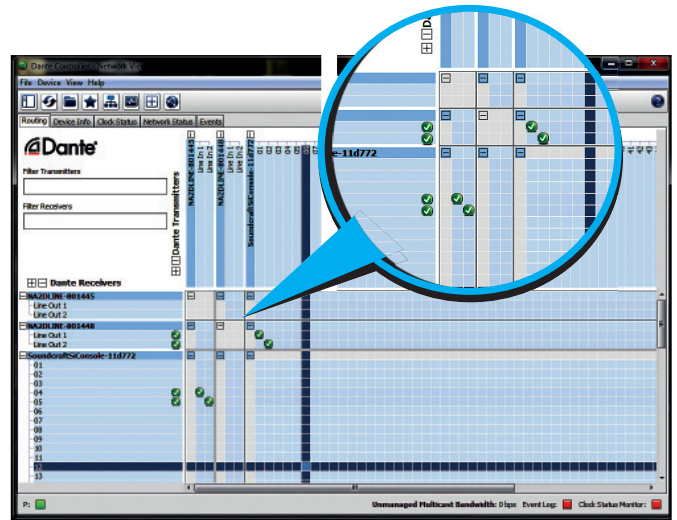

The "Dante™ Controller" software is used only to set up the audio connection (routing) between devices and to configure the subscribing devices. The devices are controlled in the DPRO Controller App.

## 5.5 DPRO Controller App

DPRO Controller allows user to control audio parameters, monitor the status of the device, recall, save and load presets. The app is available for PC and Mac.

### 5.5.1 Downloading and installing DPRO Controller App

 DPRO Controller App is available for PC and Mac, free of charge. Please review the system requirements in the technical data before installing the app.

- ▶ Download the app on the Neutrik website: [www.neutrik.com/en/support/downloads](http://www.neutrik.com/en/support/downloads).

#### Installation on Windows

- ▶ Execute the downloaded .exe file and follow the installation steps.
- ✓ The installation wizard creates an entry in Start menu and a link on your Desktop.

#### Installation on OS X

- ▶ Execute the downloaded .dmg file and follow the installation steps.
- ✓ The DPRO Controller App is installed on computer.



DPRO Controller app icon

### 5.5.2 Connecting devices with the app

- ▶ Connect the devices as required.
- ▶ Start up the DPRO Controller.
- ✓ The devices are connected with DPRO Controller automatically.

### 5.5.3 Selecting the device to edit



- ▶ In the connected devices list (1), click on the device name.
- ✓ The selected device is marked with a green line on the left side.

### 5.5.4 Setting input parameters



- ▶ Change MIC/LINE: Click the **MIC/LINE** button.
- ▶ Activate/deactivate the -16 dB attenuator: Click the **PAD** button.
- ▶ Activate/deactivate the low-cut filter: Click the **80Hz** button.
- ▶ Activate/deactivate phantom power: Click the **+48V** button.
- ▶ Adjust gain: Click and hold the gain knob and move the mouse.
- ▶ Link/unlink input channels: Click the **Link/Unlink** button.

## 5.5.5 Setting output parameters



- ▶ Mute/unmute channel:  
Click the **MUTE** button.
- ▶ Adjust output volume:  
Click and hold the fader button and move the mouse up or down.
- ▶ Jump fader to 0:  
Hold Ctrl/Cmd and click on the fader.

## 5.5.6 Presets

Presets allow user to save the settings of the devices that are connected to the app.

### Create preset

- ▶ Click in the menu **File > Create Preset...** or use the shortcut **Ctrl/Cmd + N**.
- ✓ The **Create a new preset** window appears.

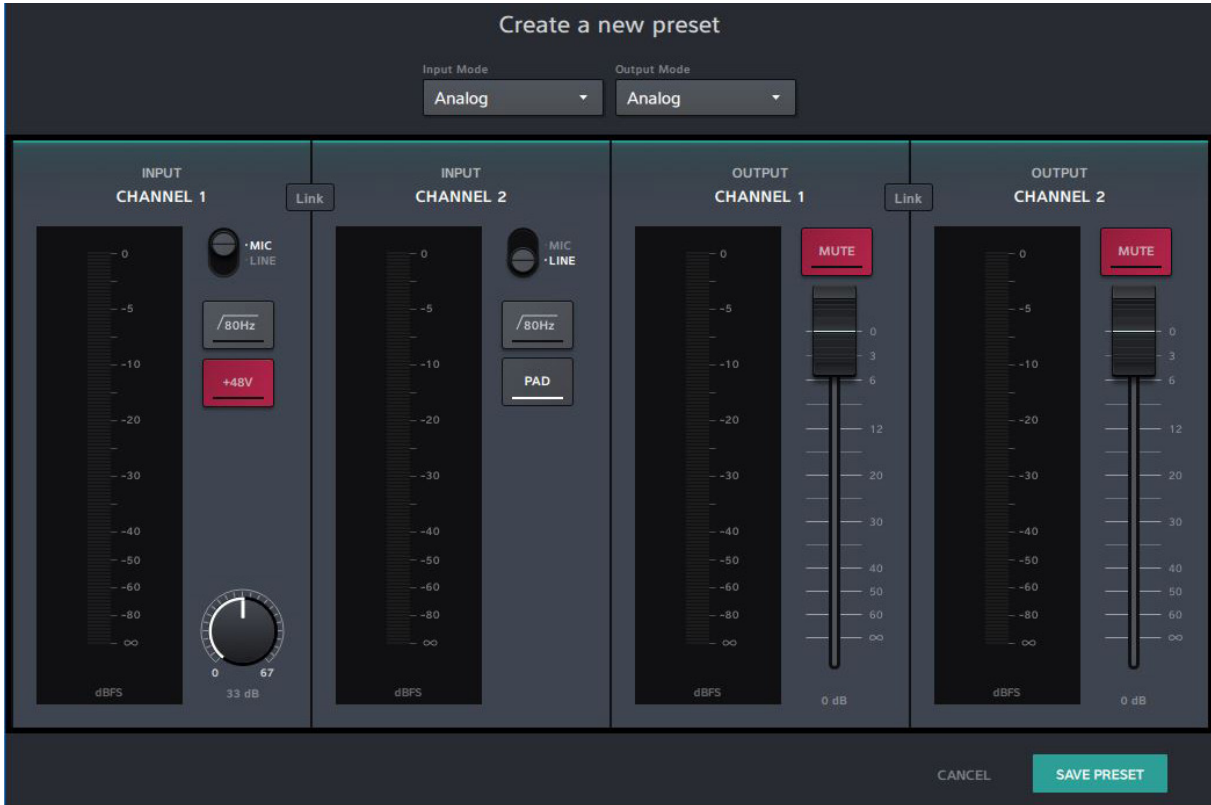

- ▶ In the drop down menu, select the Input Mode and the Output Mode (None, Analog, AES) depending on your application.
- ▶ Set your parameters.
- ▶ Click the **SAVE PRESET** button to save the preset as .dap file on your computer.

## Load Preset

- ▶ Click in the menu **File > Load Preset...** or use the shortcut or **Ctrl/Cmd + L**.

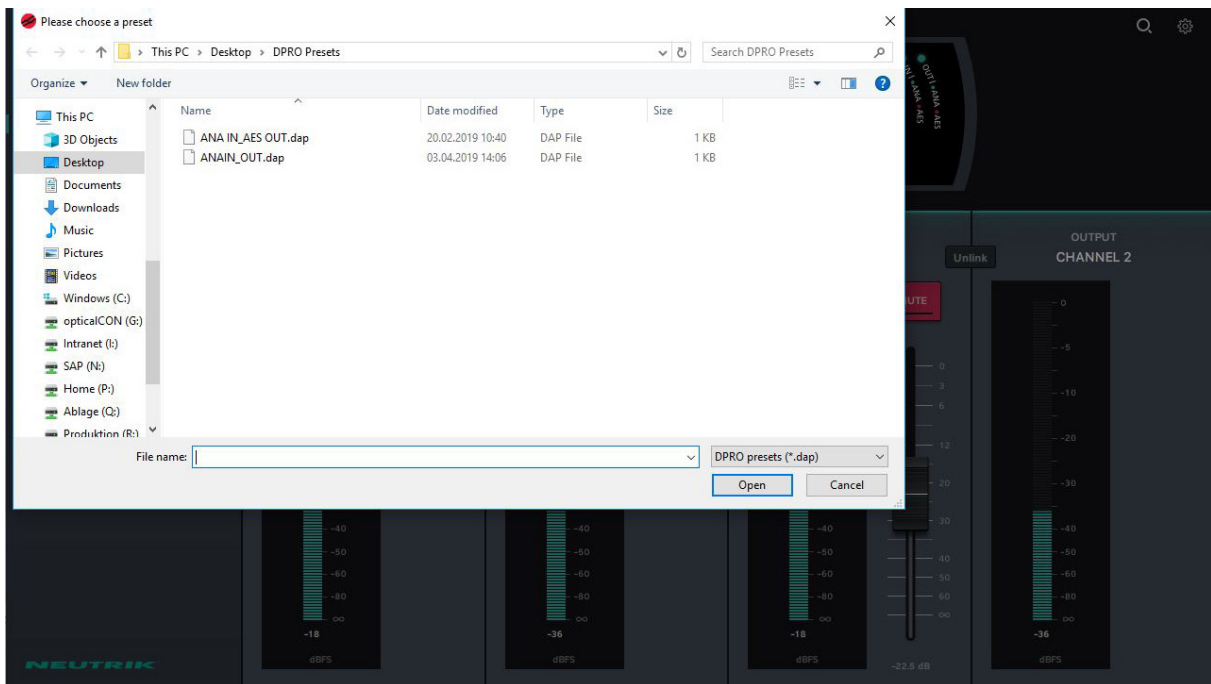

- ▶ Select a .dap file on your computer and click the **Open** button.
- ✔ The **Load preset** window appears, which shows a preview of the preset to be loaded.

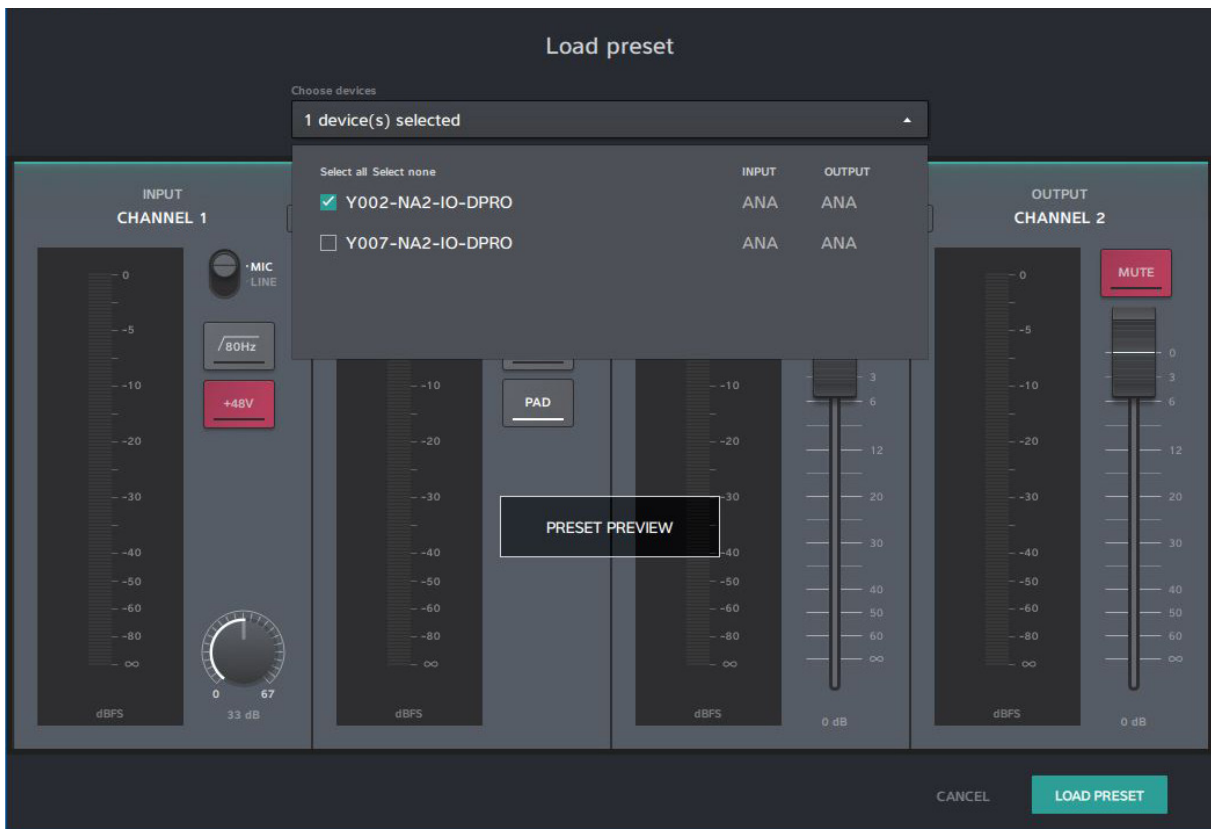

- ▶ In the drop down menu, select your devices.
- ▶ Check if the connected input/output signals matches with the preset modes (ANA/AES).
- ▶ To load the preset, click the **LOAD PRESET** button.

- ✓ If Load Preset was not successful, the Load Preset mismatch screen appears.

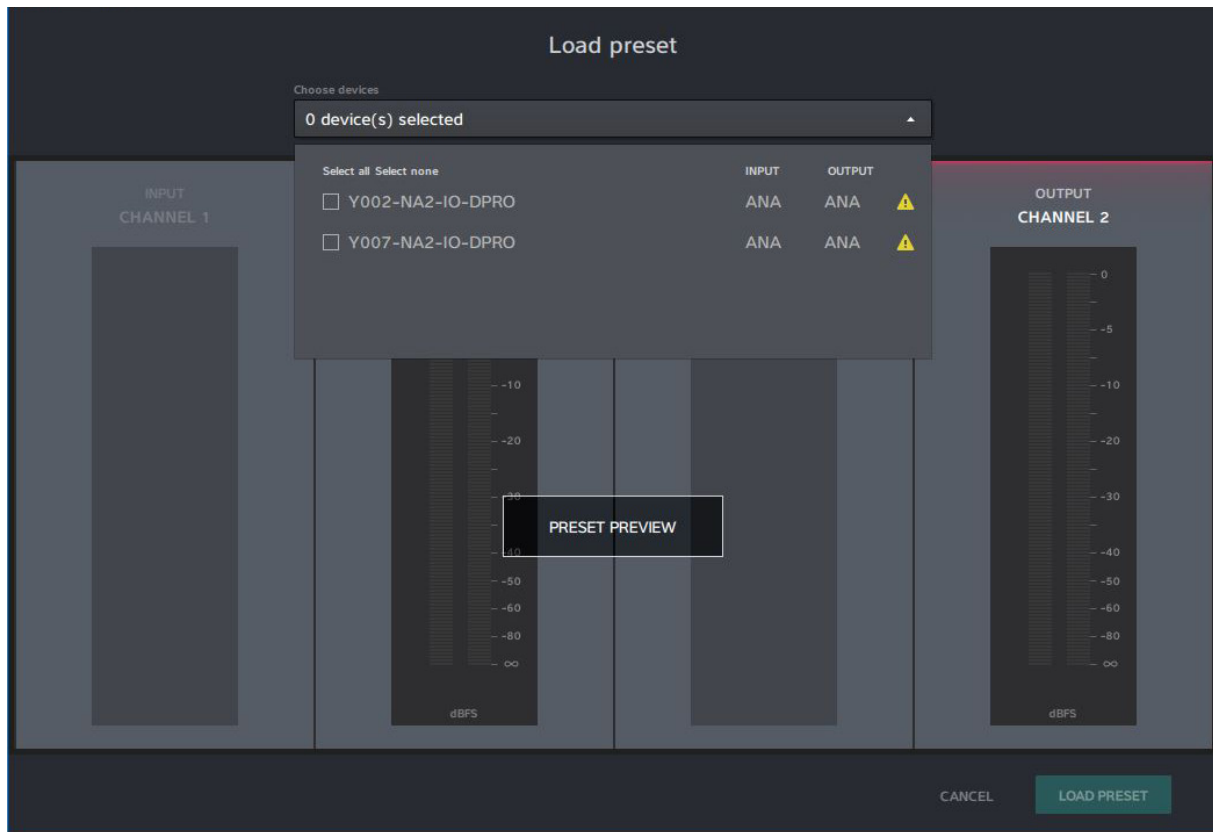

- ▶ Check the device's input/output connections:  
For analog signal use channel 1 and channel 2.  
For AES signal use channel 2.
- ▶ Try to load the preset again or load another preset.
- ▶ If no matching preset is available, create a new preset.



More information about the modes and switching logic please find in section "4.3.3 Modes and switching logic of the DPRO Adapter" on page 11.

## Save Preset

- ▶ Click in the menu **File > Save As Preset...** or use the shortcut **Ctrl/Cmd + S**.

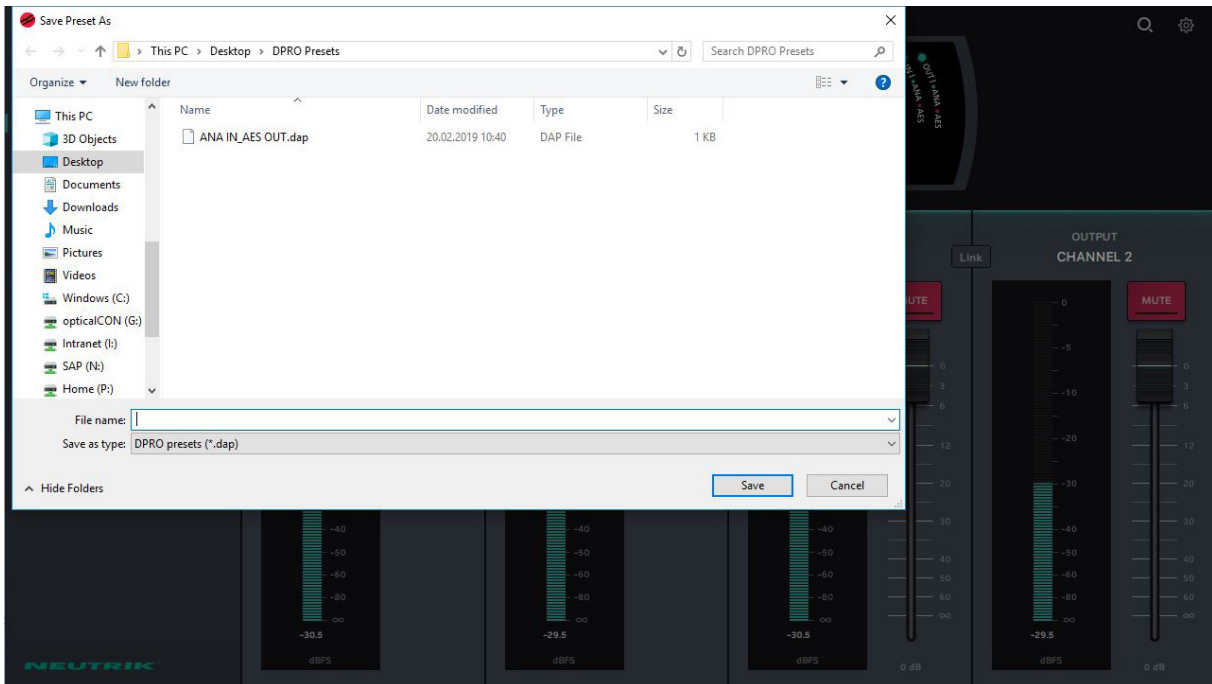

- ▶ Enter a file name and click the **Save** button.

## 5.5.7 Identify device

- ▶ Select the device to identify.

Option 1:

- ▶ Click in the menu **Device > Identify Device**.

Option 2:

- ▶ Click the device status overview the identify device button .

Option 3:

- ▶ Use the shortcut **Ctrl/Cmd + I**.

- ✓ The LEDs of the device flash up for 10 seconds.

## 5.5.8 Reset device

This option deletes all set parameters on the selected device. The device remains connected to the app. There are two ways to reset the device.

### Hardware reset

The hardware reset resets the following parameters:

- If MIC is active: Gain = 0 dB, HPF and Phantom power will be off.
- Network settings: Reset to Factory default (DHCP enabled).
- Outputs Mute will be off.

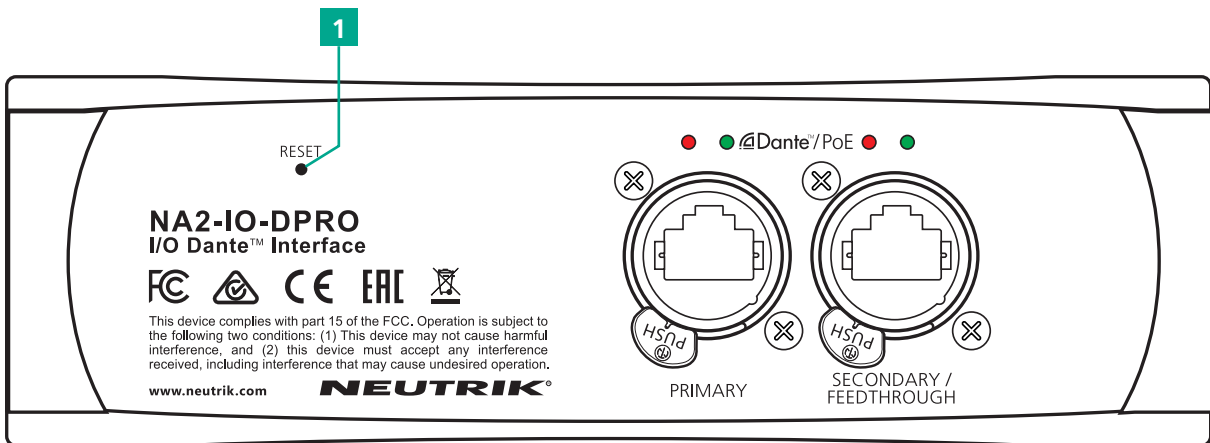

- ▶ On the back of the device, push the RESET button (1) for approx. 5 seconds.
- ✓ Device is reset.

### Software reset

The software reset resets the following parameters:

- If MIC is active: Gain = 0 dB, HPF and Phantom power will be off.
- Network settings: Reset to Factory default (DHCP enabled).
- Outputs Mute will be off.

- ▶ Click in the menu [Device > Reset Device....](#)
- ✓ The Reset Devices window appears.

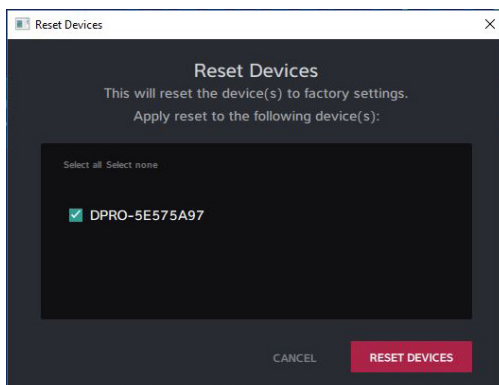

- ▶ Select the devices you want to reset.
- ▶ Click the [RESET DEVICES](#) button.
- ✓ The devices are reset.



## 5.5.9 Network Settings

The internal IP address can be set in 2 modes.

### Automatic

The device obtains the IP address from DHCP server or locally from the computer.

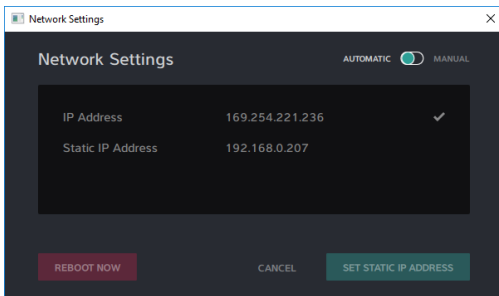

### Manual

The user defines the IP address manually.

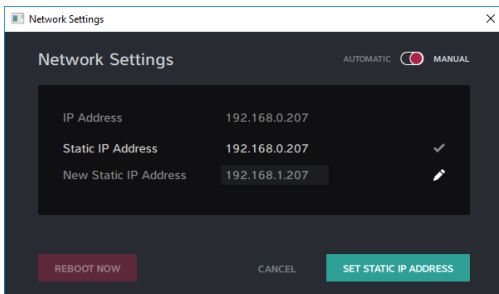

- ▶ Choose the **MANUAL** mode.
- ✓ A new line to enter New Static IP Address appears.
- ▶ Click the  icon to enter the static IP address.
- ▶ Click the **SET STATIC IP ADDRESS** button.
- ▶ Reboot the device:
  - Click the **REBOOT NOW** button.
- ✓ The static IP address is assigned to the device.

### 5.5.10 Firmware Upgrade

**i** With the Firmware Upgrade function in the DPRO Controller app user can only upgrade the Neutrik's firmware of the device. To upgrade the Dante™ Firmware, please use the Dante™ controller

- ▶ Download the Firmware Upgrade on the Neutrik website: [www.neutrik.com/en/support/downloads](http://www.neutrik.com/en/support/downloads).
- ▶ In the DPRO Controller app, select the device to upgrade.

Option 1:

- ▶ Click in the menu [Device > Firmware Upgrade](#).

Option 2:

- ▶ Click the device status overview the device settings button
- ✓ The [Device Settings](#) window appears.

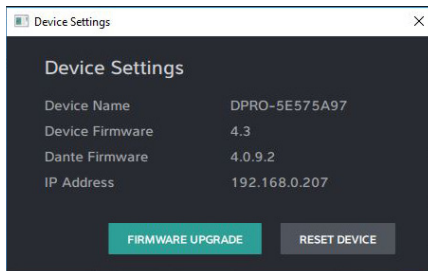

- ▶ Click the [FIRMWARE UPGRADE](#) button.
- ✓ The [Firmware Upgrade](#) window appears.

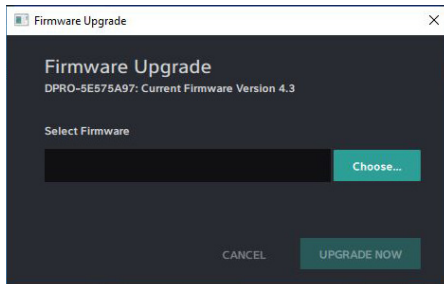

- ▶ Click the [Choose...](#) button and select the downloaded upgrade file.
- ▶ Click the [UPGRADE NOW](#) button.
- ✓ The device's firmware upgrade will be installed.

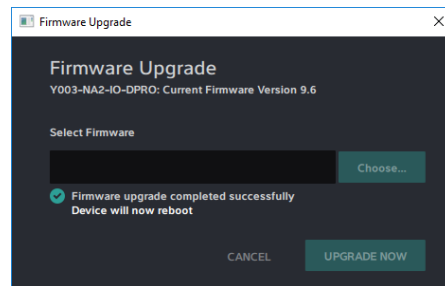
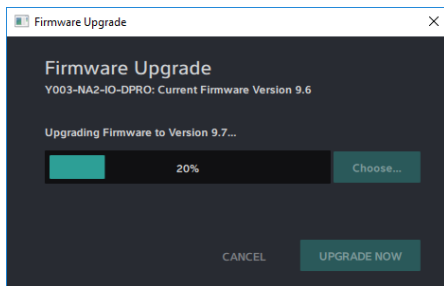

- ✓ During the upgrade the progress bar shows the upgrade progress.
- ✓ If the upgrade is completed, the message [Firmware upgrade completed successfully](#) appears.
- ✓ The device starts rebooting.

## 5.6 Accessories assembly instructions

### NOTE

Use only original Neutrik screws to prevent damage to the device.

### 5.6.1 Mounting brackets

The mounting brackets make it possible to mount the device in floor boxes, underneath tables, etc.

#### Scope of delivery

#### Assembly of the mounting brackets

Prepare the following tools:

- ☑ Torx Screwdriver (T10)



2 brackets



2 fixing screws



2 torx screws



2 spacers



- ▶ Remove the rubber protection.



- ▶ Mount a bracket, a spacer and a screw on the device as shown on the picture.
- ▶ Tighten the screw with the screwdriver.
- ▶ Repeat these steps on the opposite side of the device.



- ▶ Mount the fixing screw as shown on the picture.
- ▶ Repeat these steps on the opposite side of the device.



- ▶ Turn the brackets as required for the mounting situation.
- ▶ Tighten the fixing screw firmly.

## 5.6.2 Rack panel

### Scope of delivery

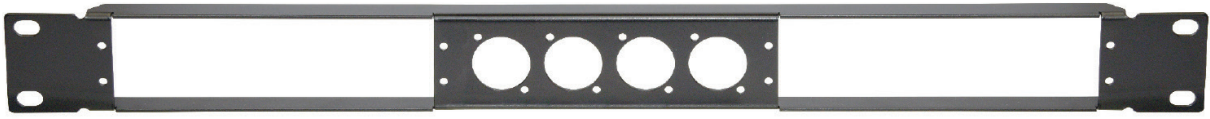

1 rack panel

### Assembling the rack panel

Prepare the following tools:

- ☑ Crosshead screwdriver



- ▶ Remove the rubber protection.



- ▶ Remove the 4 screws on the front of the device.



- ▶ Place the device in the rack panel.
- ▶ Fix the device with the four screws.

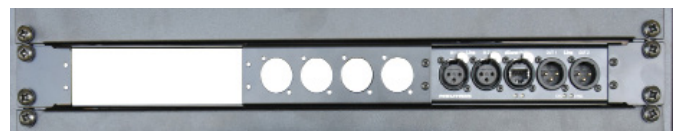

## 6 After Operation

### 6.1 Dismounting devices

- ▶ Disconnect devices from audio sources/sinks.

### 6.2 Transporting

- ▶ Always transport devices and accessories in their original packaging.

### 6.3 Storage

- ▶ If devices are not used for a longer period:  
Disconnect the device from the connected devices.
- ▶ Always store devices in a clean, dry location.
- ▶ Always protect devices from dirt, dust, heat, humidity and moisture.

### 6.4 Cleaning and care

#### NOTE

#### **Danger of property damage due to improper cleaning!**

- ▶ Disconnect device from all connections before cleaning.
  - ▶ Never immerse device or accessory in water under any circumstances.
  - ▶ Never spray device or accessory with liquids under any circumstances.
- 
- ▶ Wipe the surfaces of the device and accessory with a soft cloth slightly moistened with a mild soap solution.
  - ▶ Never use aggressive, solvent-based or abrasive cleaning agents under any circumstances.
  - ▶ Never use rough materials (e.g., cleaning cloths or sponges with a rough coating).

### 6.5 Maintenance and repair

The DPRO Adapter does not contain any parts that can be maintained or repaired by the user.

- ▶ Only have the DPRO Adapter repaired by a specialist dealer authorized by Neutrik.
- ▶ Check the DPRO Adapter regularly for visible damage to the housings, controls, connections, cables and plugs.
- ▶ If damage is detected, do not use device under any circumstances.
- ▶ Immediately decommission the damaged device.
- ▶ Replace defective cables or accessories immediately.

## 6.6 Disposal



- ▶ Dispose of the DPRO Adapter and accessories in accordance with the applicable local regulations.
- ▶ Never dispose of electrical devices or electrical accessories such as cables, plugs, batteries or components with household wastes under any circumstances.

- ▶ Dispose of packaging and packaging elements in accordance with the applicable local regulations.
- ▶ Take device components made of plastic, metal or other recyclables for reclamation in accordance with the applicable local regulations.

## 7 Appendix

### 7.1 Technical specifications

#### Dante™ specifications

Channels	2 INPUTS (Line Level / Mic / AES / EBU) 2 OUTPUTS (Line Level / Mic / AES / EBU)
Supported sampling rates	44.1 / 48 / 88.2 / 96 kHz
Bit depth	16, 24 and 32 Bit
Latency	based on user selection 0,25 ms (Dante)
Ethernet connection	1.000 BASE-T (supporting PoE)

#### Electrical specifications

Power consumption	< 6 watts
Power supply	1.000 BASE-T (supporting PoE) or PoE midspan power injector (according to IEEE 802.3af/at, class 2)

#### Analog audio input

Equivalent input noise	-128 dBu (67 dB Gain); A-weighted
Gain hub (3 dB Steps)	0 – 67 dB
Max. input level	+24 dBu (PAD enabled) +8 dBu (PAD disabled)
Input impedance	> 7.5 kOhm, balanced
Frequency response	20 Hz to 20 kHz ( $\pm$ 0.5 dB)
Dynamic range	> 112 dB, BW 22.4 kHz, A-weighted (input gain = min.)
Signal-to-noise ratio	> 112 dB, BW 22.4 kHz, A-weighted
THD + noise	< 0.005 % (20 Hz to 20 kHz, +4 dBu)
Crosstalk	-100 dB, adjacent INPUT/OUTPUT channels (input gain = min.)

#### Analog audio output

Output impedance	< 150 Ohm, balanced
Max. output level	+24 dBu
Residual output noise	-88 dBu, A-weighted
Frequency response	20 Hz to 20 kHz ( $\pm$ 0.5 dB)
Dynamic range	> 112 dB, BW 22.4kHz, A-weighted
Signal-to-noise ratio	> 112 dB, BW 22.4kHz, A-weighted
THD + noise	< 0.005% (20 Hz to 20 kHz, +4 dBu)
Crosstalk	-100dB, adjacent INPUT/OUTPUT channels (input gain = min.)

## Mechanical specifications

Weight	0.53 kg / 1.17 lbs
Dimensions (with rubber protection)	L = 164 mm (6.4 inches) B = 82 mm (3.2 inches) H = 51 mm (2.0 inches)
Dimensions (without rubber protection)	L = 151 mm (5.9 inches) B = 66 mm (2.6 inches) H = 41 mm (1.6 inches)
Operating environment	Indoor
Operating temperature	0 °C to +50 °C
Storage temperature	-40 °C to +150 °C

## App Requirements

RAM	min. 2 GB
Display resolution	min. 1280 x 1024 px
Operating System	Windows 7 or later MAC OS X 10.12 or higher



## 7.2 PoE (Power over Ethernet)

PoE stands for Power over Ethernet and describes a practice for using a single CAT5e (or higher) to incorporate both power and data in the single cable.

Few advantages:

- Easy setup
- Single cable run up to 100 m
- Using PoE doesn't require certified electrician as the power loads are small
- Existing network infrastructure can be used

### 7.2.1 Definitions

**PD** (Powered device) – device that is connected to PSE and thus is powered by it.

**PSE** (Power Sourcing Equipment) – device that provides power to PD, Switch or injector

#### PSE Types

In our case, we consider only following two types of PSE devices.

- PoE Switch: a switch that offers possibility to power PD. Switches use PoE classification.
- PoE Injector: typically a single port device for powering 1 PD. These exist with classification (active) or without (passive).

The term class refers to a maximal power output (see table below).

### 7.2.2 PoE Standards

These standards are part of IEEE 802.3 general standards.

802.3 af – defines PoE classes 0-3

802.3 at – uses the same classes, but introduces class 4 as well.

### 7.2.3 Classes and discovery process

Discovery is a process of PSE, determining the power requirements of the PD. Once PD and PSE are connected, PSE sends out a short voltage impulse, reads the returned value and provides power accordingly. This is valid for PSE with class (also called active).

No class (passive) PSE, acts as a classic power supply, hence no discovery is implemented, and PSE supplies current at all times.

Class	Type	Power required by PoE class at the Powered Device (PD)w
1	802.3af	0.44 - 3.84 W
2	802.3af	3.84 - 6.49 W
3	802.3af	6.49 - 12.95 W
4	802.3at PoE+	12.95 - 25.5 W